

TM

WASHRAG



VOLUME 21 ISSUE 08
AUGUST 2019

Wireless Association of South Hills



N3SH WA3SH NP2SH/B

www.n3sh.org www.washarc.org



Wireless Association of South Hills

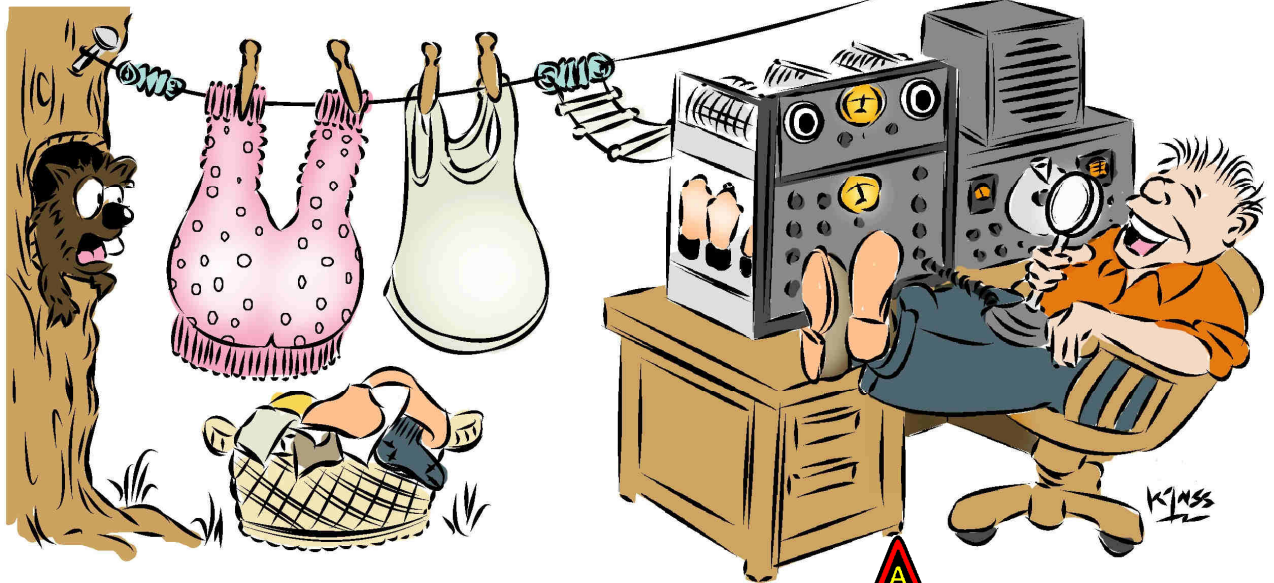

WASHRAG™



VOLUME 21 ISSUE 08

AUGUST 2019

Next Monthly Meeting: Thursday, August 1st, 2019

The next meeting of the WIRELESS ASSOCIATION OF SOUTH HILLS, INC. will be on **Thursday, August 1st 2019**, at the Eat 'n' Park at 301 South Hills Village, Bethel Park. The room is available at 6:30 PM. The meeting will be starting at 7:00 PM.

Subjects for the meeting include the upcoming trip to DX Engineering, Pa QSO 2019, and upcoming plans for the rest of 2019.

See you there!

Cover Photo: "This is why, even with quality fittings, you should ALWAYS weather protect them!"

Cover Photo courtesy of & © Copyright 2019 Glen Roberts KE7FD

WASH 2019 OFFICERS

EXECUTIVE COMMITTEE:

President	Tony Romano KB3BYA
VP / Secretary	Dan Campbell K3CMU
VP / Treasurer	Mark Stabryla N3RDV

AND WE COULDN'T DO IT WITHOUT:

N3SH Trustee	Larry Comden K3VX
WA3SH Trustee	Rich Danko N3SBF
NP2SH Trustee	Paul Jordan NP2JF
N3SH WA3SH NP2SH/B QSL Manager	Ron Notarius W3WN
NP2SH 2009 QSL Manager	Carl Schroeder K9CS
VE Team Liaison	Ron Notarius W3WN
Webmaster	Curtis Turner KB3CMT
Quartermaster	Harold Rosenberger K3HCR
WASH FM Net Manager	Chuck Bihun KC3ELA
WASHFest 2020 Committee	Carol Danko KB3GMN, Chairman
Activities & Operating Events	Bill Hill W3WH, Co-Chair
Ways & Means	Rick Bell KB3IAC
WASH 2M Contest Chair	Carol Danko KB3GMN
Field Day 2019 Coordinators	Chuck Bihun KC3ELA
	Rick Bell KB3IAC
	Bill Hill W3WH

CLUB-AFFILIATED REPEATERS, BEACONS, & DIGIPEATERS:

Mt. Lebanon	N3SH / R	146.955 MHz (-)	PL 131.8
North Side	N3SH / R	442.550 MHz (+)	PL 131.8
Canonsburg	N3FB / R	443.650 MHz (+)	PL 131.8
St. Johns, VI	NP2SH / B	28.276 MHz	Propagation Beacon
Canonsburg	N3SH	144.390 MHz	APRS Digipeater

N3SH / WA3SH WASHNet, the weekly on-air net of WASH, meets every

Monday Night, 8:00 PM ET, on the 146.955 & 443.650 repeaters.

All radio amateurs, WASH members or not, are welcome to join in!

THE LEGAL STUFF

"The WASHRag™" (formerly "The Mariner™") is the Official Newsletter of the WIRELESS ASSOCIATION OF SOUTH HILLS, INC. (WASH), a 501.C.3 not for profit organization.

Published Monthly with occasional Special Editions as warranted.

This issue is © Copyright 2019 by the WIRELESS ASSOCIATION OF SOUTH HILLS, INC.

Editor & Publisher: Ron Notarius W3WN

Permission is granted to other Amateur Radio publications to reprint articles in this issue, provided the original author and "The WASHRag™" are given credit. Comments, articles, and requests for copies of or information about "The WASHRag™" should be mailed to the editor:

Ron Notarius W3WN
3395 Rosewood Drive, Castle Shannon, PA 15234-2546
e-mail: newsletter@n3sh.org or w3wn@arrl.net

"The WASHRag", "The Mariner", SHARCfest, South Hills Hamfest, WASHfest, WASHfest 2019, N3SH Net, WA3SH Net and WASHNet are™ trademarks of the WIRELESS ASSOCIATION OF SOUTH HILLS, INC.

The WIRELESS ASSOCIATION OF SOUTH HILLS, INC. was founded on August 23rd, 1993, as the original SOUTH HILLS AMATEUR RADIO CLUB, and operated under that name through 1998. WASH was also known briefly in late 1998 as the N3SH AMATEUR RADIO CLUB. It is not in any way affiliated with the "South Hills Amateur Radio Club, Inc." and is not responsible for that group, its members, or its actions in any way, shape, or form.

As always, special thanks to the owners & operators of both the N3SH/R Repeaters and the N3FB/R Repeater System for permitting the WIRELESS ASSOCIATION OF SOUTH HILLS, INC. and its members to use their repeaters for club purposes.

WASH Amateur Radio Club News Briefs

Next WASH VE Test October 17th

The Next WASH VE exam sessions will be **Thursday, October 17th, 2019, 7:00 PM**, at the **WPXI Community Room**, 4145 Evergreen Road, Pittsburgh, PA 15214. Talk-in on the 146.955 MHz and 443.650 MHz repeaters. All examiners are ARRL VEC affiliated.

Pre-registration is not required. Walk-ins welcome!

But if you plan on attending the test session, please contact VE Team Liason Ron Notarius W3WN:

Telephone (412) 572-6723 or E-Mail: w3wn@n3sh.org

Please bring the following to your test session:

Picture ID or other suitable identification (2 forms of ID required)

Pen / Pencil / Calculator

Original FCC license plus a copy of license (if upgrading)

Original CSCE plus a copy of CSCE (if upgrading)

Check or Cash in the amount of **\$15.00** (payable to: ARRL VEC)

Future test dates: February 23rd, 2020

Tony's Musings

Welcome to the "dog days of summer"!!

If anyone is doing any outside work erecting antennas, park activations etc., Please stay hydrated drink plenty of water understand the symptoms of heat stress and stay safe!! Have a great time enjoying the summer.

— 73, *Tony Romano KB3BYA*
President, Wireless Association of South Hills, Inc.
 N3SH / WA3SH / NP2SH



The Raspberry Pi Foundation has confirmed that the recently released Raspberry Pi 4 will NOT work when powered using certain USB-C cables.

Avoid using cables intended for use by Apple MacBooks, and other "e-marked" cables.

The issue is expected to be fixed in future board revisions.

Where did July go? Seems like Field Day was just the other day, not over a month ago! As summer marches on, though, so does the **WASH Breakfast Gang**, meeting again at Eat 'N Park, 3380 Washington Road (US 19) in McMurray. The July 27th contingent included WB4GCS & Gage, N3FB, KB3GMU, W3WH, K3VX, K3HCR, N3IDH, KE7FD and W3WN. Conversations of the AM included being cleared to drive again – but don't be stupid, 160 meter antenna modeling, locating remote receivers at Channel 53, going to Kennywood, more Antenna Modeling, weather delays, no tower crew available, walking... a lot of walking... a LOT of walking..., Picklesburg, overnight trip to QVC, Allegheny County about to make the Federal Government look competent, discovering the remains of nuns, Pirates pitching woes & continuing to snatch defeat from the jaws of victory, SDR station configuration, Pa QSO antenna plans, roofs & solar panels, naked cores, cost of books at the Notre Dame bookstore, household wiring...

Our next gathering of the Gang will be on August 25th, returning to the Eat 'N Park, 3380 Washington Road (US 19) in McMurray, officially starting at **8:00 AM**. While we don't need a "head count" to reserve tables as we've previously done, please let Jim WB4GCS know ahead of time if you are planning on coming... if you don't, though and decide at the last minute, we'll have plenty of room for you! See you there?

As many of you are aware, our own Jim WB4GCS has been **under the weather** lately as he is recuperating from a medical procedure. Glad to see him at breakfast and other club events, as he is definitely on the mend! After all, what would this club be without a Sanford on the roster? (Don't answer that)

Usually we would have a short article and some pictures from the **July VE Exam**. It's not an oversight... or to put it another way, what if we sponsored a test session and no one came? And that's exactly what happened on July 18th. Probably a combination of the weather and road construction... it happens sometimes. Our thanks anyway to the VE's who did stop over, Frank N3FB, Glen KE7FD & Ron W3WN. We're sure that things will be better at the next session in October! (he says confidently)

A timely reminder... if you notice **interference on the 146.955 repeater**, please make sure you log the date & time and a summary of what you may have heard, and let Tony KB3BYA know. As many of you know, there have been reports of encroachment from users of a repeater on the same frequency in an adjacent state. If it reaches the point where something will need to be said, we (ie Tony, as Club Prez) needs to have something more than "we think we heard something." Certainly no reason why we can't all co-exist, but if a problem crops up, the sooner we can address it and resolve it, the better.

So what's up next? A few more summer and fall hamfests, some contests and other activities, and then the **2019 Pennsylvania QSO Party**. Stay tuned! (And work on your antennas, while you can!) Speaking of hamfests, W3WN is looking to share a car ride and a table for some of these in the area, please contact him if interested or available.

We didn't have room for it last month, but this picture from **W3C Field Day 2019** was just too good to not bring to light, so to speak. It's a "long view" of the main operating positions late Saturday night. Thanks Curtis KB3CMT for the photo!

And... you don't know how close you came to seeing a "dog" days photo. Keep those articles and photos coming!

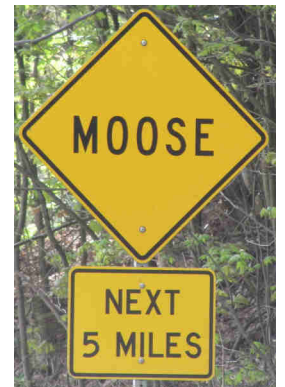
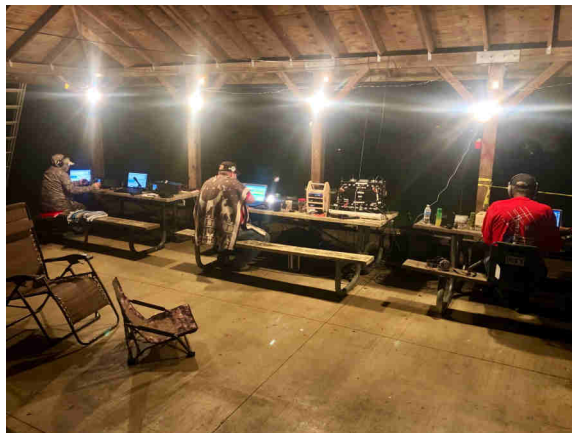

Not something you see around here that often, but a common highway sign in W1!

Join WASH or Renew your Membership Today! Membership Application on Page 13

Minutes, July 11th Meeting

Dan Campbell K3CMU, Vice President/Secretary, WASH

Change of venue: Eat'n Park, 5220 Library Rd. Bethel Park, PA 15012

Call to Order: 19:17 hours; Presiding Officer: Tony Romano (KB3BYA)

Pledge of Allegiance Moment of Silence: Silent Keys & Others

Number of Members Present: 18; Numbers of Guests: 3;

Guest(s) Name(s): Jordan Pitts (KC3NSH); Chamel Bihun, Amy Romano

COMMITTEE REPORTS

Treasurer: Mark Stabryla, (N3RDV); [Notes: Tony Romano (KB3BYA) reporting.] Motion to Accept: Bill (W3WH); Seconded by: Larry (K3VX); Passed: Yes.

Secretary: Dan Campbell (K3CMU) : Are there any corrections to the Minutes: No. Motion to Accept By: Carol (KB3GMN); Seconded by: Bill (W3WH) Passed: Yes

Repeaters: Frank Bobro (N3FB), (Reported by Jim (WB4GCS)) Any Issues?: No

WASHNet: Charles (Chuck) Bihun, III (K3CELA): Lots of new voices; commended for doing a good job ru8nning the net

Contests: Larry Comden (K3VX): Babcock Grove reserved for 2020; Dan (K3CMU) has paperwork for securing overnight permission and certificate of insurance with Allegheny County and employees as additional insureds for Field Day. Letter for overnight permission should be mailed in January. Certificate of Insurance should be requested in May. WASH has credit of \$45.00 with Allegheny County stemming from previous reservation.

Public Service: Bob Timmins (AB3ED):

- Requested more participation in AM Radio Roundtable
- "Tour for the Cure" operators requested: Saturday Sept 14th
- "Pittsburgh Great Race": Sept 29th
- "Vintage Grand Prix": July 20th, will check regarding add'l operators

Newsletter: Ron Notarius (W3WN): Published!

Volunteer Examiners: Ron Notarius (W3WN): VE Exam volunteers requested for July 18th; VE Examiners needed for October 17th

Ways & Means: Carol Danko (KB3GMN): "Double Bubble" at Aug 1st membership meeting

President's Report: (see commentary throughout minutes)

Old Business:

- Rick (KB3IAC): Source for Field Day batteries may retire in the coming year, the club may have to find alternate supplier.
- Rick (KB3IAC): experiencing 2-meter interference apparently coming from Morgantown, WV (Jordan Pitts said he was experiencing the same problem.) Conversation from members concluded the club President should notify Repeater Council.
- Jim (WB4GCS) Advised that generator testing may resume on a Saturday in late August. Curtis (KB3CMT): following-up with Honda regarding the experience with the rented Honda generator.

New Business:

- Glen (KE7FD proposed organizing a road trip to DX Engineering (Akron area) on August 10th, to explore ideas for assisting hams in selection radio equipment. The club might also wish to entertain the purchase of an ICom 7300 for both Field Day use and helping Hams familiarize themselves with higher level transceivers.
- Curtis (KB3CMT) advised that he was running a remote station from home. When asked if he could deliver a presentation on how he set this up he responded that he would be happy to.

Field Day 2019 discussion:

- Contacts: 996 total (not incld. GOTA); 531 CW; 140 digital; 300+ Phone (150 on 80 meters, 146 on 40 meters; 17 on 20 meters. 400 +/- less than 2018.
- A jumper cable seemed to be the culprit for the lower contact rate. It was discovered and fixed on day 2.
- WASH Field Day Financial Summary; submitted by Bill (W3WH)
 Field Day 2109 Budget: \$1500.00
 Food - lunch, dinner & miscellaneous food needs: \$ 346.00
 Triplexer and band Pass Filters - DX Engineering: \$ 586.99
 Signs: Dan Campbell: \$ 152.50
 Tower trailer expenses; Rick Bell: \$ 109.51
 Gasoline and Breakfast: Tony Romano: \$ 55.62

Continued on Page 8

WASH Spotlight: QRU?



Recognize the ham on the right?

Recently spotted at the Imperial Shop N Save... Paul NØVLR and long-time stuck in Philadelphia Bob Sanford AA3FI!

Photo courtesy of and © Copyright 2019 Paul Lusardi NØVLR

Every month we're going to feature a **WASH** club member, something about them, something they're involved in or a club-related activity that we're involved in, in the **WASH Spotlight**. Submissions for the Spotlight should be sent to Ron W3WN at [newsletter at n3sh dot org](mailto:newsletter@n3sh.org)

Monthly WASH Breakfast



Please join us for the next **WASH** Breakfast! We usually get together on the LAST Saturday of every month for a chance to informally sit down, shoot the breeze, compare notes, drink lots of coffee, and just have a good time!

Join us this month at **Eat'nPark**, 3380 Washington Road (US 19), McMurray. Start time is about 8 AM until ????. Monitor 146.955 & 443.659 for talk-in or any last minute changes.

All are welcome, **WASH** members or not, amateurs or not!

Wireless Association of South Hills Membership

AA3GM	KB3JHR	N3SBF	WASH FL	WASH TN	Silent Keys
AB3NM	KB3ORO	N3TDV	KA3UPY/M	K3OL	
K3CMU	KB3YCX	N3ZK	W4ZE	KE3XB	
K3GW	KC3ELA	NU3Q	WASH NE	N3YPB	
K3HCR	KC3GMM	W3LE	NØPEU	WASH TX	
K6DWR	KC3MLC	W3RON	W3LE	NB3C	
KA3VXM	KC4WTT	W3WH	WASH OR	K3LGM	
KB3BYA	KE7FD	W3WN	KB3NVL	KB3IJX	
KB3CMT	N3DFK	W3PYU	KB3NVM	Jane Wagner	
KB3DCO	N3FB	WA3VSS	WASH OH	WASH VI	
KB3GMN	N3KFD	WA3WXR	N8DPW	NP2JF	
KB3GMU	N3RDF	WB4GCS			
KB3IAC	N3RDV	WO3Z			
KB3IVX					

If your call should be listed here & isn't, please contact Mark N3RDV

Through July 3rd, 2019
 List compiled by
 Mark Stabryla N3RDV, Vice President/Treasurer

- AB3KA
- K3EED
- K3LIE
- KA3NMG
- KB3ENX
- KB3FNM
- KB3FQT
- KB3JHQ
- N3CZZ
- N3FZ
- N3HKQ
- N3KEH
- N3OBD
- N3RNX
- N3SKR
- N3SRC
- N3ZEL
- N3XFE
- W3ZLK
- WA3JPP

2019 WASH Upcoming Events Calendar

Club Meetings & Other Significant Events — Subject to Change

August 1 st	<i>WASH</i> Meeting	St. Clair Hospital Outpatient Center, 2000 Oxford Drive, Bethel Park 15102
August 25 th	Skyview Radio Society Swap N Shop	K3MJW Clubhouse, 2335 Turkey Ridge Road, New Kensington PA 15068
August 31 st	Uniontown ARC Gabfest	W3PIE Clubhouse, 433 Old Pittsburgh Road, Uniontown PA 15541
September 5 th	<i>WASH</i> Meeting	St. Clair Hospital Outpatient Center, 2000 Oxford Drive, Bethel Park 15102
September 8 th	Butler Co ARA Swapfest	Unionville Fire Hall, 102 Mahood Road, Butler PA 16001
October 3 rd	<i>WASH</i> Meeting	St. Clair Hospital Outpatient Center, 2000 Oxford Drive, Bethel Park 15102
October 12 th –13 th	63 rd Pennsylvania QSO Party	https://www.paqso.org
October 17 th	<i>WASH</i> VE Exams	WPXI Community Room, 4145 Evergreen Road, Pittsburgh PA
October 26 th –27 th	CQ Worldwide DX Contest SSB	https://www.cqww.com
November 2 nd –4 th	ARRL Sweepstakes CW	http://www.arrl.org
November 3 rd	WACOM Hamfest	Washington County Fairgrounds, 2151 North Main Street, Washington PA
November 7 th	<i>WASH</i> Meeting	St. Clair Hospital Outpatient Center, 2000 Oxford Drive, Bethel Park 15102
November 16 th –18 th	ARRL Sweepstakes Phone	http://www.arrl.org
November 23 rd –24 th	CQ Worldwide DX Contest CW	https://www.cqww.com
December 5 th	<i>WASH</i> Meeting	St. Clair Hospital Outpatient Center, 2000 Oxford Drive, Bethel Park 15102
December 6 th –8 th	ARRL 160 Meter Contest	http://www.arrl.org
December 14 th –15 th	ARRL 10 Meter Contest	http://www.arrl.org
December 22 nd	ARRL Rookie Roundup CW	http://www.arrl.org
December 28 th –29 th	Stew Perry Topband Challenge	http://www.kkn.net/stew/

"Seen" at the July Meeting

Photos Courtesy of and © Copyright 2019 Ron Notarius W3WN



What's New?

Bill Hill W3WH

Chartiers Township, PA, July 20th, 2019 – For me not a whole lot that interests me, is new. Maybe that's not good but who knows?

Actually after beginning this article I discovered there's enough that's new and interesting even for me.

Now that the 160 dx season is kaput until the Fall and new countries and entities are scarcer than the proverbial hen's teeth (that happens when you have over 300 worked), Band conditions are downright crummy and what does a committed CW OP do to stimulate interest and fun in his lifelong hobby?

One thing I'm doing is planning a new 160 antenna. I've been using a 43 foot vertical with two 45 foot top wires and lots of ground radials underneath. This has been combined with various dedicated receiving antennas such as loops, delta loops etc. There's no room for a beverage antenna when you live in a town house. This has served me well enough to achieve 160 DXCC but just like I regularly change radios I also like trying new antenna schemes.

The new vertical will be quite similar to the current antenna except it will be a bit taller and will use a folded counterpoise instead of ground radials (no more radials sliced by the lawnmowers). K2AV came up with the FCP for a friend who moved to a small lot that lacked enough space for sufficient ground radials. Also instead of being 43 foot high, it will be about 55 feet in the air. A modest increase but I hope every little bit helps. More about the antenna results in a later article.

In the meantime what to do? After all Field Day is over and how many "599 TU" QSO's or Ragchews can one have without losing interest. Well it seems there is always something. Events such as the annual 13 Colonies during July 4th week and the IARU dx contest provides a forum to chase IARU Headquarters stations and the most recent is the periodic activation of the Sovereign Military Order of Malta. For those of you who aren't aware this is a tiny (just a few acres) independent entity located associated with the Roman Catholic Church in Rome similar to the Vatican. When they get on every couple of years, it's fun to chase them.

Looking ahead, planning for the PaQSO Party is underway. This event is always fun and most years it's also a bit frustrating when you miss a clean sweep of the Pa. Counties by one or two. N3ZK et al doesn't know how this feels since they always seem to get their sweep. Anyway it's a worthwhile event to consider and everyone should do their best to take advantage of the fun it offers.

I guess my conclusion is that no matter where your interests in our wonderful hobby lie there is always something new and interesting going on deserving of your leisure time.



Antenna construction has begun! Photos courtesy of and © Copyright 2019 William R. Hill W3WH

Millions of AMPRNet Internet Addresses Sold to Fund Grants & Scholarships

American Radio Relay League

Newington, CT, July 25th, 2019 – The proceeds from this month's sale of some 4 million unused consecutive AMPRNet internet addresses will fund operations of the non-profit Amateur Radio Digital Communications ([ARDC](#)), establishing a program of grants and scholarships program in support of communications and networking research — with a strong emphasis on Amateur Radio, a lengthy ARDC [news release](#) said.

ARDC manages AMPRNet. The sale to what ARDC is calling "a very big company with a significant internet presence" fetched "several million dollars." ARDC said that its Board of Directors had agreed to keep the exact figure confidential for now, "to avoid adversely influencing others buying and selling addresses."

The addresses sold came out of a block of some 16 million internet addresses ("Internet network 44") obtained nearly 40 years ago and "devoted exclusively to Amateur Radio" for TCP/IP ham radio networking. Ownership of the addresses passed on to an informal group of hams that included Phil Karn KA9Q, Wally Lindstruth WA6JPR (SK), and later, Brian Kantor WB6CYT. Karn and Kantor remain on the ARDC Board.

"It was our unanimous decision to place one-quarter of the AMPRNet address space on the market and to prudently invest the proceeds of that sale in what we hope will be a perpetual endowment from which each year we will award grants and scholarships to qualified recipients who will use the funds to advance the state of the communications arts," ARDC said in its statement.

ARDC said it intends to grant funds "across all reaches of the educational, research, and development spectrum," with awards going toward the support of qualified IRS 501(c)(3) organizations.

ARDC said that it would be "extremely doubtful" that radio amateurs someday need the addresses that were sold. "The hams still have over 12 million addresses and are using far fewer than half of those.

No grants or scholarships have been granted as yet. ARDC said it's forming a committee to screen future candidate organizations.

More information about AMPRNet can be found on the AMPRNet Wiki, http://wiki.ampr.org/wiki/Main_Page



"If an antenna falls in the forest, and no one is there to see or hear it, does it's SWR change?"

Clinton Herbert AB7RG

"Modern technology is great and all, but there's still magic when you put a signal on a wire hung in your yard, and talk by CW or voice around the world!"

Thomas Fortin W6SWO

Characterizing the KE7FD 1:1 Balun

James A. Sanford WB4GCS, P.E.

Initiation Date: 20 July 2019
Participant(s): WB4GCS
Initial Symptoms: N/A
Actions: Warm up HP8714C Network Analyzer
 Calibrate for S11 and S21 from 1.8 – 30 MHz.,

Observations:
 Transmission is good.
 Return loss is a bit disappointing, but useable.
 25db of return loss is around 1.11 SWR.
 19.85db of return loss is around 1.23 SWR.
 14db of return loss is around 1.49 SWR.
 9db of return loss is around 1.93 SWR. I don't think I'd use this on 20M or 15M.
 I did measure return loss with a precision termination rather than the network analyzer input; no better

Analysis:
 Transmission is good.
 Return loss is a bit disappointing, but useable.
 25db of return loss is around 1.11 SWR.
 19.85db of return loss is around 1.23 SWR.
 14db of return loss is around 1.49 SWR.
 9db of return loss is around 1.93 SWR. I don't think I'd use this on 20M or 15M.
 I did measure return loss with a precision termination rather than the network analyzer input; no better

Hypothesis: N/A
Plan: I will give this a try on the NVIS 80M short (loaded) dipole.
Results: As above.
Conclusion: Usable on 160, 80 and 40 Meters.

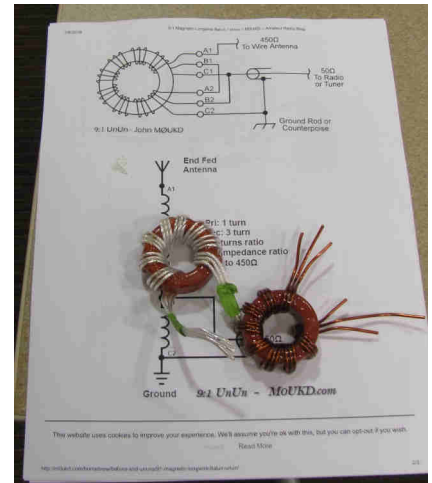
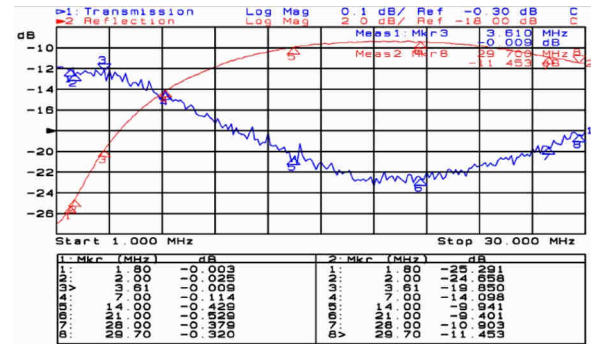

Review: Ten Tec Omni VII+

Bill Appleton KG2CS

Homestead, FL, July 29th, 2019 – The Omni 7+ arrived this week. I have been putting it through its paces comparing it to my Yaesu FTDX 9000 Contest, the Yaesu FTDX 3000, and some of the newer ICOM Rigs. (Yes, I know how you feel about ICOM audio. Me too.)

The fit and finish of the rig is improved with a metal front and better quality knobs. The review is to say that this is a clear winner in my humble opinion.

The noise reduction algorithms do not add a lot of artifacts which has been a complaint with my other rigs. The noise blanker which is also adjustable, seemed effective with some my noise created by a neighbor running some equipment.



Also, I've got my lot of unsolicited positive audio reports from other hams wondering what I was running. I can have nice rich audio, and then at a moment's notice I can change the bandwidth and compression and chase DX. And I have done both. BTW, I did work some of the IOTA contest this weekend on 20 phone. 20 / S9 signals were within the few KC from where I was working. No AGC pumping, and I was able to pinch the filters down to a little over a KC. The Yaesu has some AGC pumping in AB testing.

As a behavior analyst I may spend several hours at a time so I can type reports in my office. My informal test is can I stand 8 or 10 hours of an HF rig on all day. Only the Ten Tec left me feeling at the end of the day not fatigued. As a musician, it's all about the sound.

So, I hope Ten Tec can make a go of it and being viable option for those of us who are looking for the best sounding receiver is possible, along with transmitting the most pleasing signal as possible.

This rig isn't going anywhere. Very enjoyable, and thank you for taking the time to read this!

Meeting Minutes

Continued from Page 4

20-meter Band Pass filter from 2018 but not reimbursed at that time:
 Larry Comden: \$ 130.00
 Total \$1380.62
 Due WASH: \$ 119.62

Good of the Order:

- Rules for 2019 PA QSO concern CW and Sideband only. Digital modes have been dropped.
- Tony (KB3BYA) reporting for Mark (N3RDV): Sponsored "Countyline Multi-Operator" plaque was not made or used. The money allocated for the plaque will be escrowed for use in 2020.
- Rick (KB3IAC) suggested modifications for the tower-trailer and funds be allocated for this at some point.
- Install a 12-volt winch that offered hand-cranking capability
- Paint the trailer next spring (2020).
- Tony (KB3BYA) suggested that a policy be developed regarding the use of the trailer by members and non-members.
- Rick (KB3IAC) suggested that the club plan an emergency exercise for St. Clair Hospital. The hospital is extremely busy now and this issue has a relatively low priority. The club should take the initiative.
- Curtis (KB3CMT) suggested that a safety orientation be conducted for the use of the trailer. Tabled for August 2019 meeting.

MOTION TO ADJOURN: By: Bill (W3WH), Seconded By: Carol (KB3GMN), Passed unanimously

Meeting Adjourned: 20:25 hours

Some European Telecom Regulators Keeping an Open Mind on French 2 Meter Proposal

American Radio Relay League

Newington, CT, July 24th, 2019 – At least two European telecommunications regulators appear inclined to give serious consideration to a French proposal to allocate 146 – 148 MHz to the Aeronautical Mobile Service on a primary basis. A number of International Amateur Radio Union (IARU) Region 1 member-societies have written their governments' regulators, expressing opposition to the proposal, aired at a June CEPT meeting. The matter remains a regional issue at this stage but could become an agenda item for World Radiocommunication Conference 2023 (WRC-23).

In response to a letter from Switzerland's IARU member-society USKA to telecommunications regulator BAKOM, the agency's head of frequency planning assured USKA that this was not a matter of depriving radio amateurs of primary use, but said "so-called co-primary" usage of 144 – 146 MHz by both services could be examined.

"We don't see how the Amateur Radio Service...and the Aeronautical Service could co-exist without operating restrictions," USKA said in a report that asks, "Is the 2 Meter Band Threatened?" The article's author, Bernard Wehrli HB9ALH, advised radio amateurs to keep using 2 meters and to avoid taking on the issue individually. "Of course, our goal is to preserve primary use of the 2-meter band, and we will do our utmost to avert such 'co-primary' usage," Wehrli said, adding that USKA was in close contact with the German and Austrian IARU member-societies.

Meanwhile the Netherlands IARU member-society VERON reports what it called a "disappointing response" from national regulator Agentschap Telecom to a call from Dutch radio amateurs that 144 – 146 MHz be protected. According to VERON, an initial Agentschap Telecom response indicated that the French proposal "fits in with Dutch frequency policy" that encourages joint and shared use of spectrum. VERON said Agentschap Telecom has indicated that it's necessary to take a good look at actual use of the segment and to have insight into compatibility.

On July 20th, radio amateurs in the Netherlands conducted a 2-meter "propagation experiment" aimed, at least in part, at demonstrating that hams use and need the band. "VERON shares the opinion that this proposal has no viability," the organization asserts, pointing to remarks from IARU President Tim Ellam VE6SH/G4HUA that said the proposal to share 144 – 146 MHz would require 4 years of studies and reach the same conclusion.

Radio Society of Great Britain (RSGB) President Dave Wilson MØOBW also wrote to the UK's telecoms regulator Ofcom, strongly expressing the RSGB's concerns about the effort to put the issue of including 144 – 146 MHz among bands for Aeronautical Mobile Service use on the WRC-23 agenda.

Wilson said RSGB "views the French proposal as lacking a proper understanding of the implications of sharing an aeronautical application with weak-signal terrestrial and space communications services."

Ellam told ARRL this week that he's not concerned that some telecommunications regulators are giving serious consideration to the French proposal at this point. "I think this is just part of the ongoing discussions," he said.



FAA Reauthorization Act Serves to Exclude Vast Majority of Amateur Radio Towers

American Radio Relay League

Newington, CT, July 12th, 2019 – Language in the Federal Aviation Administration (FAA) [Reauthorization Act of 2018](#) will exclude all but a small number of Amateur Radio towers from marking requirements. Thanks to action taken in 2017 and 2018 by ARRL, the bill's original language was amended to the extent that amateur towers, as well as residential towers used for over-the-air TV reception, were effectively exempted from marking requirements.

The topic was addressed at the annual "Ham Radio and the Law" forum at the [Dayton Hamvention](#)® this past May. Some key points from that presentation: (1) Towers covered by the rules are structures at least 50 feet tall that support an antenna and are located in a rural area or on farmland or immediately adjacent to such land. (2) According to the Act, the term "covered tower" does *not* include any structure that is adjacent to a house, barn, or other building, and "is within the curtilage of a farmstead or adjacent to another building or visible structure."

ARRL Regulatory Information Manager Dan Henderson N1ND explains that, while a few Amateur Radio towers will fall under the Act's marking requirements and will have to be registered, towers in residential yards or within farmland are specifically exempted.

[More information](#) is on the ARRL website.



"Spider On The Roof!" KE7FD has a new HF antenna!

Photos courtesy of and ©Copyright 2019 Glen Roberts KE7FD (left) and Bob Greene N3RDG (right)



Myanmar Update

Simon Luttrell HSØZIB / XZ2A

Phuket Island, Thailand, July 19th, 2019 – I just want to update my situation.

I operated as XZ2A from Myanmar (Burma) last year, restricted to 20 MHz and above.

I left Myanmar towards the end of last year, because I now teach 'online' and the Myanmar internet gateway is a bit of a bottleneck.

My apologies to those who have yet to receive my QSL card. I'm sitting on the last bunch of about 100 completed cards already in envelopes and ready to send out. The problem is that the Thai post office has to process every single envelope by hand. Manually typing in the address details etc. The last time I sent out a bunch of cards, the local post office got angry with me, and it took over 1 hour...

Next time around, I will definitely use an overseas QSL manager.

As far as Myanmar is concerned, I know that XZ2B and XZ2C both have operating permits. Be aware that according to the law in Myanmar, each permit is issued for a maximum of 5 months, and can only be renewed once for the same time period. So 10 months of operation above 20 MHz and at 25 watts output power is all that can be expected.

Anyway, from the middle of August, I'll be based in the town of Luang Prabang, in North Laos. I used to live in LP around 2013 when I was the headmaster at the local school. This time round, I'm just teaching online (now Laos has very fast and reliable internet). I hope not to move again!

I just got back from a meeting with the Lao licensing authorities, and should pick up my XW license in a week or so. Initially, I will only operate on 20 meters, primarily using FT8 and SSTV.

2019 Cass Awards

Dave Bernstein AA6YQ

Wayland, MA, July 25th, 2019 – Sponsored by Club Log, DXLab, and the Northern California DX Club, the [Cass Awards](#) encourage DXpedition operating excellence by recognizing DXpeditions that work the most unique callsigns.

Single-Operator Cass Award

While QRV from St. Eustatius Island as PJ5/SP9FIH during March 2018, Janusz SP9FIH worked 8257 unique stations during 14 consecutive days of his one-man DXpedition. Janusz has won the Single-Operator Cass Award for the second year in a row - from locations on two different continents!

Unlimited Cass Award

Also during March 2018, Girts Budis YL2KL, Yuris Petersons YL2GM, and Kaspars Uztics YL1ZF worked 18,812 unique stations as 3CØW on Annobon Island, winning the first Unlimited Cass Award and demonstrating an outstanding effort to log as many DXers as possible.

Cass Awards

Presented annually, the Cass Awards encourage DXpeditions to maximize the number of DXers worked with a plaque for the Single-Operator DXpedition that works the most unique callsigns during a two-week interval, and a plaque for the "unlimited" DXpedition that works the most unique callsigns; the rules for each award are defined [here](#).

Running leaderboards for the 2019 Cass Awards are available here:

- [Single-operator](#)
- [Unlimited](#)

These awards honor the wisdom and spirit of Cass WA6AUD (SK), whose stories in the West Coast DX Bulletin taught a generation of DXers that DX IS!

Congratulations to Bill Hill W3WH for achieving 9 Band DXCC!

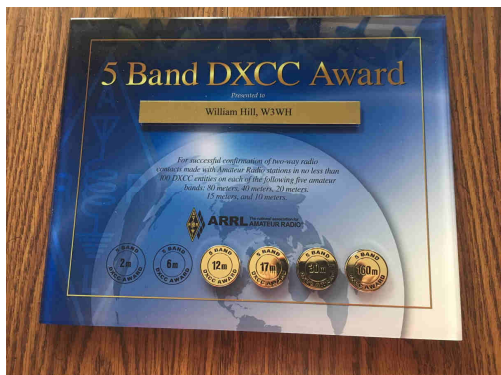

DX News Briefs



According to his twitter feed and other reports, Man SØ1WS was hospitalized after suffering a heart attack. He was transferred to Spain for further treatment.

The operators of the 5C9A DXpedition to new IOTA AF-118 Los Farallones Island were informed 30 minutes prior to boarding the aircraft (prior to the July 26th start date) that the expedition was "not going ahead." The team alleges that the trip was "subverted by the Association Royale des Radio Amateurs du Maroc (ARRAM)" even though they had all their permits and permissions in place. More information on why the expedition was "prevented from happening" has not been made available, to the team or to the Amateur Radio community.

The CY9C DXpedition is scheduled to be QRV 31 July – 8 August, 160 – 6, CW SSB FT8 EME & Satellites. Three vehicles full of equipment and antennas are waiting at the takeoff point for helicopter transit, however, the helicopter itself had an instrument failure and required equipment replacement, which caused a 1 to 2 day delay. The team states that a partial setup/operation is still expected for Wednesday, with full operation by sometime on Thursday. More information at <http://cy9c.com> QSL via WA4DAN

S53R will be QRV from Kabul as T66A starting in early September. He expects to be there for about 2 years. During contests, he will be QRV as T6A. Look for him 160-6 CW & SSB in his spare time. QSL via S53R

LA7GIA will again be QRV as 6O7O starting in September for 14 days, 160 – 10, primarily CW. More information available at <https://www.la7gia.com/where-next/> QSL via MØOXO

TR8CR will again be QRV during October & November 2019, 40 – 17, CW & SSB. Previous logs can be found on the LNDX web site at <http://lesnouvellesdx.fr/voirlogs.php> QSL via F6AJA

KB1QU will be QRV as 9G5QU 8-21 September on 40, 30, 20m; CW, FT8/FT4. QSL via N4GNR

A group of operators will be QRV as TO8ØSP from NA-032 (FP) 2 – 14 October, 160 – 10 CW SSB & Digital modes. More information at <http://www.dl7df.com/fp> QSL via DL7DF

VU7RI will be QRV from Lakshadweep Island AS-011 19 – 31 October, 80 – 6 with a focus on the higher bands, CW SSB & FT08. More information at <https://vu7ri.com> . QSL via MØKRI

FM/JF2QNM will be QRV from NA-107 24 – 28 October, Holiday style focusing on 30 17 & 12 meters, CW & SSB. During the CQ WW SSB Contest he will be QRV as TO1J. QSL both via JF2QNM

K7AR will be QRV as V63AR 18 – 26 November, including the CQ WW CW contest. Special attention will be given to 160 & 80 meters, looking for the US East Coast, Europe, and the Caribbean.

QSL Routes

5P2I via OZ2I	ESØDJ via ES2DJ	R66IOTA via UAØLCZ
5P6G via DD5ZZ	GBØDAM via GM4FZH	RT5G/1 via RA1QQ
7S7SOP via SM7RYR	GB5ØWAB via G7GJU	SP/MØPLX via SP7DPJ
9A2L via 9A3DF	GM7V via N3SL	SW8YA via HA1YA
9A8TQF via HB9TQF	HC1MD via K8LJG	T6A via S53R
9H6YB via G3SWH	II3Y via IV3OSC	T66A via S53R
CY9C via WA4DAN	JT1QP/6 via DJ8QP	TM5S via F5MFV
DK3R via DL1KZA	LA/OK3EE via OK1DBS	TM7P via F4FET
DL7ØAFUG via DM4EAX	MJØIKL via OK1DOL	TO1J via JF2QNM
DX9EVM via DU9CA	MM3T via GMØELP	TX2A via W6NV
E44WE via SP9FIH	NL8F via N7RO	UR1G via UR8GX
ED1K via EA1NK	OE19LAWN via OE3IPC	VB1D via VA1YL
ED7O via EA7EU	OG5A via OH5AD	VK4NM via MØOXO
EJ3Z via EI6GUB	R63RRC via R7AA	YJØCA via VK2YUS
EG3MDS via EA3IAZ		YJØGA via ZL3GA

Thanks to the NJDXA DX News Reflector, the DX-QSL Reflector, 425 DX News, OPDX News, DX Coffee, DX World.Net, ICPO Bulletin, & ARRL DX Bulletin for our DX News information. Thanks also to the ARRL DXCC Desk, & Bernie McClenny W3UR / The Daily DX for confirmations & additional information.



WASH Classifieds

Information shown here is as supplied to the **WASHRag**. Condition as stated, and all sales should be considered "as-is" unless otherwise noted. All subject to prior sale or withdrawal from sale at the owner's discretion. All responsibility for this information lies with the source and not the **WASHRag** or the **WIRELESS ASSOCIATION OF SOUTH HILLS, INC.**

HAM RADIO INSURANCE ASSOCIATES, INC.

P.O. Box 201
Canonsburg, PA 15317-0201
Toll-Free 1-800-545-8881

Fax: (412) 746-5944

bill.hill@hamradioinsurance.com

"All-Risk" Amateur Radio Equipment Insurance Plan for:

- Radio Equipment
- Antennas Rotors & Towers
- Mechanical Breakdown & Electrical Damage Coverage
- Computer Equipment
- Computer Media & Software



Antenna Zoning or PRB-1 Issues?

Contact: **Michael S. Lazaroff K3AIR, Esquire**

Lazaroff & Suhr, Attorneys at Law
277 West Main Street, Saxonburg, PA 16056
Phone: 724-352-4905

The **WASHRag** Masthead is courtesy of Jeff Murray K1NSS, creator of DASHToons & Dash the Dog Faced Ham!!

Find the online cartoons and stories of Dash the Dogfaced Ham & more at <https://www.jeffk1nss.com> !

Shop for Dash items at his online store on Café Press, www.cafepress.com/shopdash



FCC FCC News

Courtesy of the American Radio Relay League

Newington, CT, July 16th, 2019 – ARRL-initiated efforts for rival parties to reach consensus on some of the issues they raised in the so-called "Symbol Rate" proceeding have ended.

In April, the FCC granted ARRL's request for a 90-day hold in the proceeding, FCC Docket WT 16-239, to provide an opportunity for ARRL to lead an effort to determine whether consensus could be reached on some or all of the issues that commenters have raised in the FCC's proceeding. The FCC already has issued a **Notice of Proposed Rulemaking** in WT 16-239, which stemmed from ARRL's rulemaking petition RM-11708. Discussions were since widened to include issues raised in another **Petition for Rule Making, RM-11831**, filed by Ron Kolarik KØIDT that seeks, in the words of his petition, "to ensure Amateur Radio digital modes remain openly decodable and available for monitoring" by the FCC and by other third parties, including other radio amateurs. His petition also aims to limit Automated Controlled Digital Stations (ACDS) to identified HF sub-bands, to reduce interference. Last month, ARRL filed an **interim report** with the FCC summarizing its efforts to bring all sides to the table, and on June 28th, ARRL requested an additional 60-day pause to pursue promising talks.

"In seeking the delay, it was the ARRL's intent to facilitate discussions between the opposing parties in an effort to explore the possibility of an agreed resolution that would better protect users of the Amateur Radio spectrum from interference and would permit all members of the Amateur Radio service to continue to contribute to the advancement of the radio art," ARRL Washington Counsel David Siddall K3ZJ said, summarizing the situation in a July 15th letter to the FCC. "The end purpose, if a binding agreement between the opposing parties could not be reached, was to provide the strongest possible basis for the ARRL to file its recommendations on a fair and equitable resolution of the issues."

Siddall said that despite difficulties "partially attributable to the passions of the respective parties," ARRL was able to schedule meetings with both sides and, eventually, joint discussions among the respective parties.

"When this process began, we expressed our intention to reach a common understanding of issues and to agree on their resolution insofar as possible," Siddall said in his letter. "At the beginning of our meetings there emerged consensus on the issues to be discussed. By the end, the parties had reached consensus on some of the issues, but not all. Despite our best efforts, some of the parties did not agree to submit to the Commission any of the recommendations on which there had been an apparent consensus, having negotiated with an "all or nothing" approach."

Despite the disappointing conclusion, Siddall expressed confidence that a better understanding of issues and positions of the various interests exists among all of the parties who participated in the in-person meetings and teleconferences, and that this will have an overall positive effect upon the outcome of the proceeding.

Siddall said ARRL remains committed to providing the FCC with its best recommendations on a fair and equitable resolution of the issues, after it has had an opportunity for discussion and deliberation.

"The ARRL membership is composed of radio amateurs with a broad array of interests in technical and experimental domains that range from creating and using satellite technologies to long-haul emergency message handling," Siddall concluded. "The ARRL is committed to promoting and protecting the interests of all Amateur Radio operators as it continues to address amateur interests and concerns."

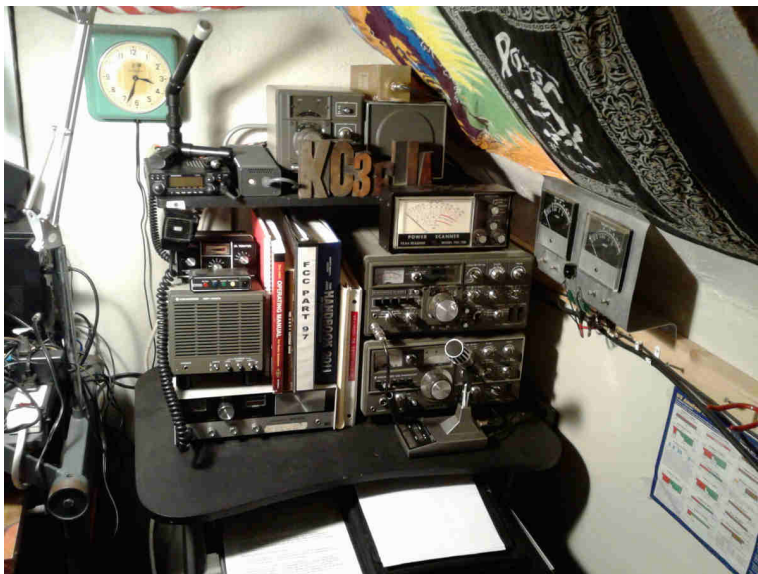

"I was cleaning and organizing so I could fit my new radio (this handsome TS- 820 procured from KB3CMT Curtis), and thought the desk looked pretty charming. " — Chuck KC3ELA

If you've downloaded the **WASHRag** from the N3SH web site, or picked up a copy from a friend... you can sign up to have the PDF copy sent directly to your email. You **do NOT** have to be a member of **WASH!**
Just send an email to wa3sh-subscribe@yahooogroups.com and the automation should take care of the rest!

Has Roadway found the tower yet?

US Amateurs by Class as of July 28th, 2019:

Novice	9,367
Technician	414,158
General	189,470
Advanced	42,944
Extra	154,201
Club	12,730
Total	822,878
All-Time High	02/11/2019 825,088
Last 90 Days:	
New Amateurs	6,929
Callsign Changes	2,557
Class Changes	3,674
No Longer Licensed	6,808
All Updates (*)	28,891
(*) Includes renewals, address changes, etc.	

Information gathered from FCC Daily Updates, courtesy of Hamdata.com

Skyview Radio Society "Swap N Shop"

Sunday, August 25th, 2019, 8:00 AM—???

Vendor Setup prior to 8:00 AM

K3MJW Clubhouse

2335 Turkey Ridge Road, New Kensington, PA 15068

Talk-in on 146.64 PL 131.8 Admission \$5

More Information at <http://www.skyviewradio.net>



Uniontown ARC 70th Annual Gabfest

Saturday, August 31st, 2019, 8:00 AM—???

Vendor Setup prior to 8:00 AM

W3PIE Clubhouse

433 Old Pittsburgh Road, Uniontown PA 15401

Talk-in on 147.045 PL 131.8 Free Admission

More Information at <http://www.w3pie.org>



Butler County ARA Swapfest 2019

Sunday, September 8th, 2018, 8:00 AM—3:00 PM

Grounds Open at 6 AM for Vendors & Tailgaters

Unionville Volunteer Fire Department

102 Mahood Road (at Route 8 North), Butler, PA 16001

Talk-in on 147.360 PL 131.8 Admission \$5

More Information at <http://www.w3udx.org>



WACOM Hamfest 2019

Sunday, November 3rd, 2019, 8:00 AM—3:00 PM

Washington County Fairgrounds

[2151 N. Main Street, Washington PA 15301](http://www.wacomarc.org)

Talk-in on 146.700 PL 131.8 Admission \$5.00

More Information at <http://www.wacomarc.org>

Or Contact Tom Wright KC3TOM tom.pghmtb@gmail.com





WIRELESS ASSOCIATION OF SOUTH HILLS, INC.

Membership Application, New or Renewal



I would like to join WASH! I am interested in the following type of membership: **New Membership** **Membership Renewal**

(check quarter _____) →
(check one)

1st Qtr Jan-Mar **2nd Qtr** Apr-Jun **3rd Qtr** Jul-Sept **4th Qtr** Oct-Dec

- (F1) Full Membership: \$20.00 \$15.00 \$10.00 \$5.00
- (F2) Full Membership < 18 or > 65 yrs of age: \$10.00 \$7.50 \$5.00 \$2.50
- (A1) Associate Membership: \$10.00 \$7.50 \$5.00 \$2.50

(FM1) Family Membership (\$3.00 x No. of household family members): \$ _____

Name(s): _____

Name: _____

Call Sign: _____

Address: _____

License Class: _____

City, State: _____

Expires On: _____

Home Phone: _____

Work Phone: _____

Email Address: _____

Birthday: _____

New Members Only:

- I do NOT want to be added to the Club E-Mail Reflector
- I do NOT want to be added to the Electronic Newsletter Mailing List

ARRL Member? Yes No Family ARRL Member? Yes No

Date: _____

[If you have an Email address, you Will be added to both lists UNLESS you choose to Opt-Out]

Amount Enclosed: \$ _____

Signature: _____

N3RDV has requested that all membership requests and renewals include an application so that his information is up to date

Please make your check or money order payable to the club treasurer, Mark Stabryla. The Wireless Association of South Hills, Inc. reserves the right to accept or reject new memberships or renewals. Please return completed membership form along with check/money order to the club treasurer or mail to:

WIRELESS ASSOCIATION OF SOUTH HILLS, INC.
c/o Mark Stabryla N3RDV, VP/Treasurer
1120 McKnight Drive
Bethel Park, PA 15102-2456



DXers have a choice!



Get a free two week trial of The Daily DX and The Weekly DX and decide for yourself which one best fits your needs for informing you of all the DX news!

Send an email to bernie@dailydx.com or go to www.dailydx.com

The Daily DX, 3025 Hobbs Road,
Glenwood, MD 21738 Phone: 301-854-5650



Arhhh!
What Mightst We Draw For Ye, Matey?

K1NSSDESIGN
CUSTOM QSL ART
HAM GRAPHICS
WEB COMICS
www.dashtoons.com
k1nss@dashtoons.com

HANDMADE BY GNOMES.

2019 WASH Meeting Location

St. Clair Hospital Outpatient Center Conference Room

2000 Oxford Drive, Bethel Park PA 15102

Adjacent to Village Square Mall, across Ft. Couch Road from
South Hills Village Mall, just off of US Route 19

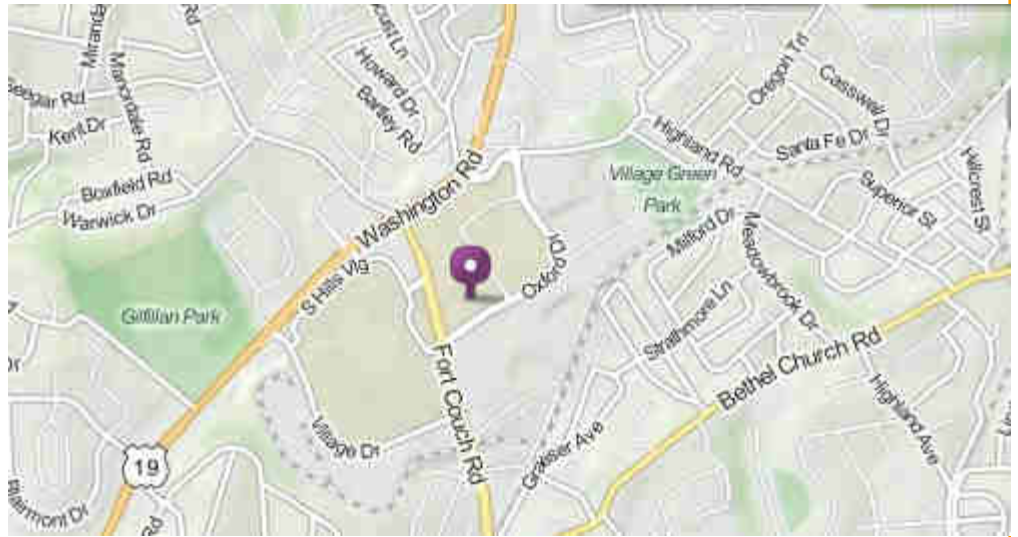
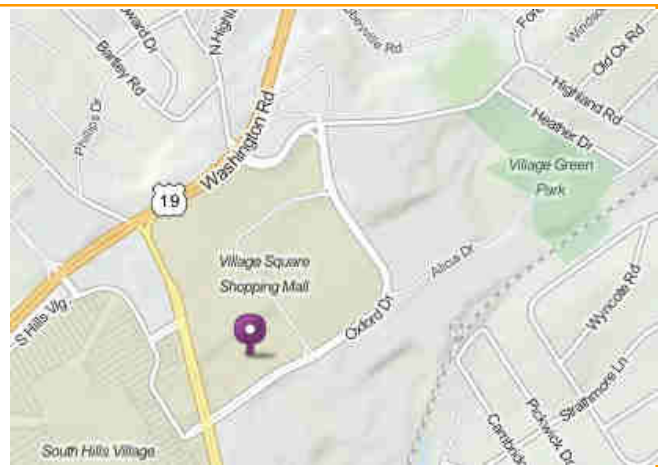

The WASHRag

Wireless Association of South Hills, Inc.

Ron Notarius W3WN, Editor

3395 Rosewood Drive

Castle Shannon, PA 15234-2546



N3SH / WA3SH
NP2SH/B

www.n3sh.org
www.washarc.org

